



iCyPhy

With thanks to:
Andrés Goens
Marten Lohstroh
Christian Menard
Mehrdad Niknami
Christopher Gill
Martin Schoeberl
Marjan Sirjani
Matt Weber

Reactors for Real-Time Systems

Edward A. Lee

Colloquium d'Informatique de Sorbonne Université

Paris, France, Feb. 25, 2020



University of California at Berkeley



Cyber-Physical Systems

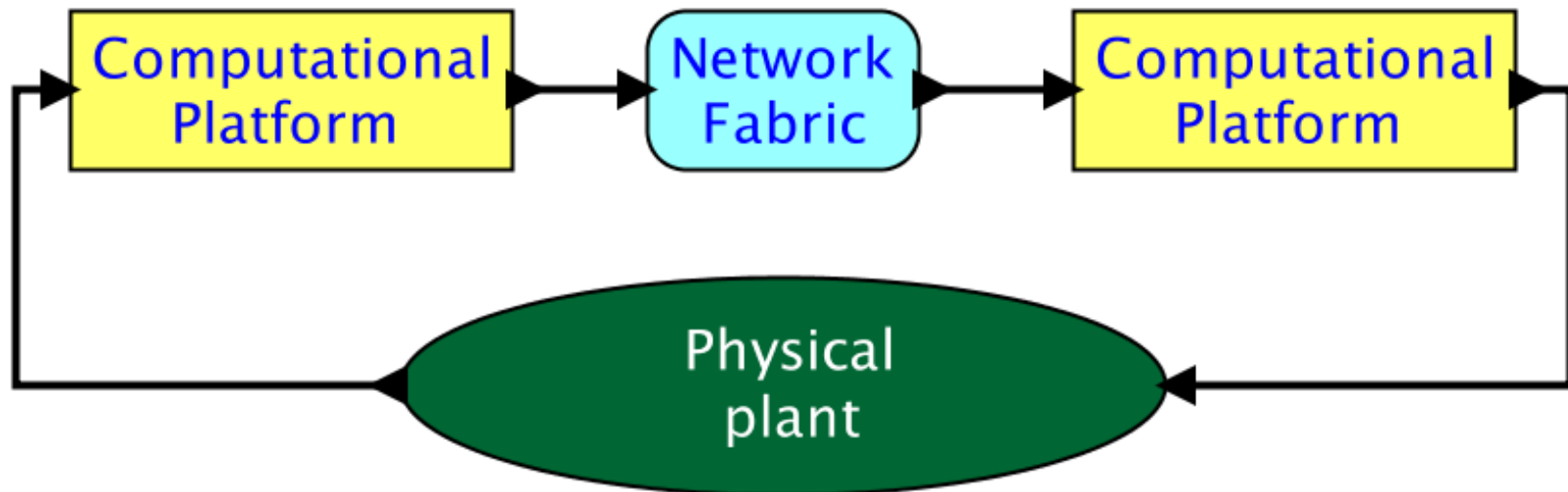

The major challenge: **Integrating complex subsystems** with adequate **reliability, repeatability, and testability**.



A Simple Challenge Problem

An actor or service that can receive either of two messages:

1. “open”
2. “disarm”

Assume state is closed and armed.

What should it do when it receives a message “open”?



By Christopher Doyle from
Horley, United Kingdom -
A321 Exit Door, CC BY-SA 2.0



A Simple Challenge Problem

An actor or service that can receive either of two messages:

1. “open”
2. “disarm”

Assume state is closed and armed.

What should it do when it receives a message “open”?

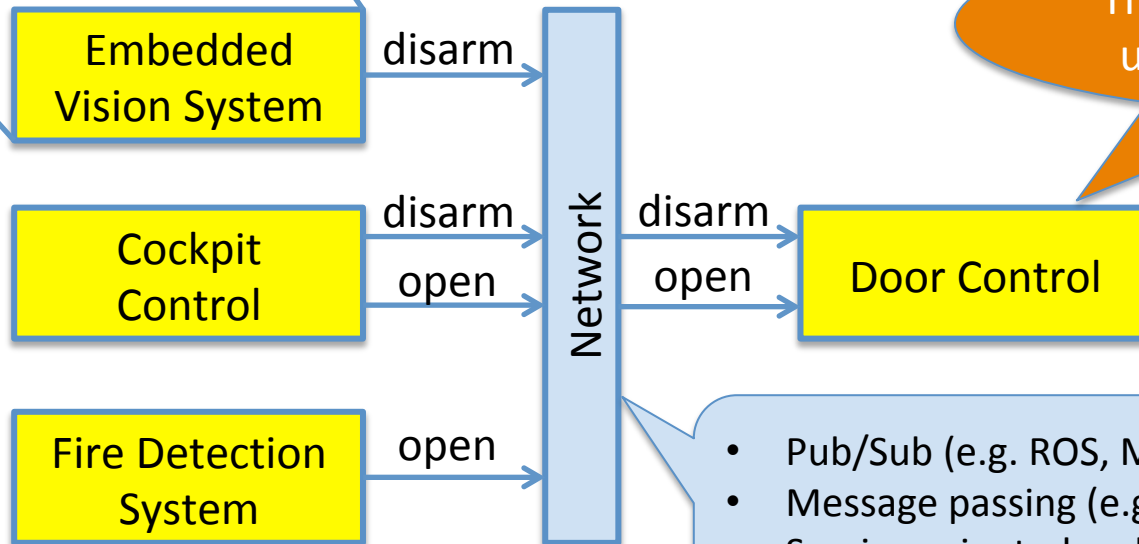

Image from *The Telegraph*, Sept. 9, 2015

Possible Architectures



Realized with an NI



The question: What to do upon receiving “open”?

- Pub/Sub (e.g. ROS, MQTT, Azure, Google Cloud)
- Message passing (e.g. Akka, Erlang)
- Service-oriented architecture (e.g. gRPC, Thrift, ...)
- Shared memory (e.g. Linda)



Some Solutions (?)

1. Just open the door.

How much to test? How much formal verification? How to constrain the design of other components? The network?

2. Send a message “ok_to_open?” Wait for responses.

How many responses? How long to wait? What if a component has failed and never responds?

3. Wait a while and then open.

How long to wait?

Better go read all of
Lamport's papers.





This problem occurs whenever
the *order of actions* matters.



Fix with formal verification?

One possibility is to formally analyze the system.

Properties to verify:

1. If Door receives “open,” it will eventually open the door, even if all other components fail.
2. If any component sends “disarm” before any other component sends “open,” then the door will be disarmed before it is opened.

Can these be satisfied?



Fix with formal verification?

One possibility is to formally analyze the system.

Properties to verify:

1. If Door receives “open,” it will eventually even if all other components fail.
2. If any component sends “disarm” before any other component sends “open,” then the door will be disarmed before it is opened.

Makes a distributed-consensus solution challenging.

Requires comparing times of events on distributed platforms in a model of computation that lacks time.



Can these properties be satisfied?

Properties to verify:

1. If Door receives “open,” it will eventually open the door, even if all other components fail.
2. If any component sends “disarm” before any other component sends “open,” then the door will be disarmed before it is opened.

Conjecture: These two cannot be satisfied (for a sufficiently complex program) without additional assumptions (e.g. bounds on network latency and/or clock synchronization).



Popular Techniques

- Publish and Subscribe
 - ROS, MQTT, DDS, Azure, Google Cloud
- Actors
 - Akka, Erlang, Orleans, Rebeca, Scala ...
- Service-oriented architecture
 - gRPC, Bond, Thrift, ...
- Shared memory
 - Linda, pSpaces, ...



Hewitt/Agha Actors

Data + Message Handlers

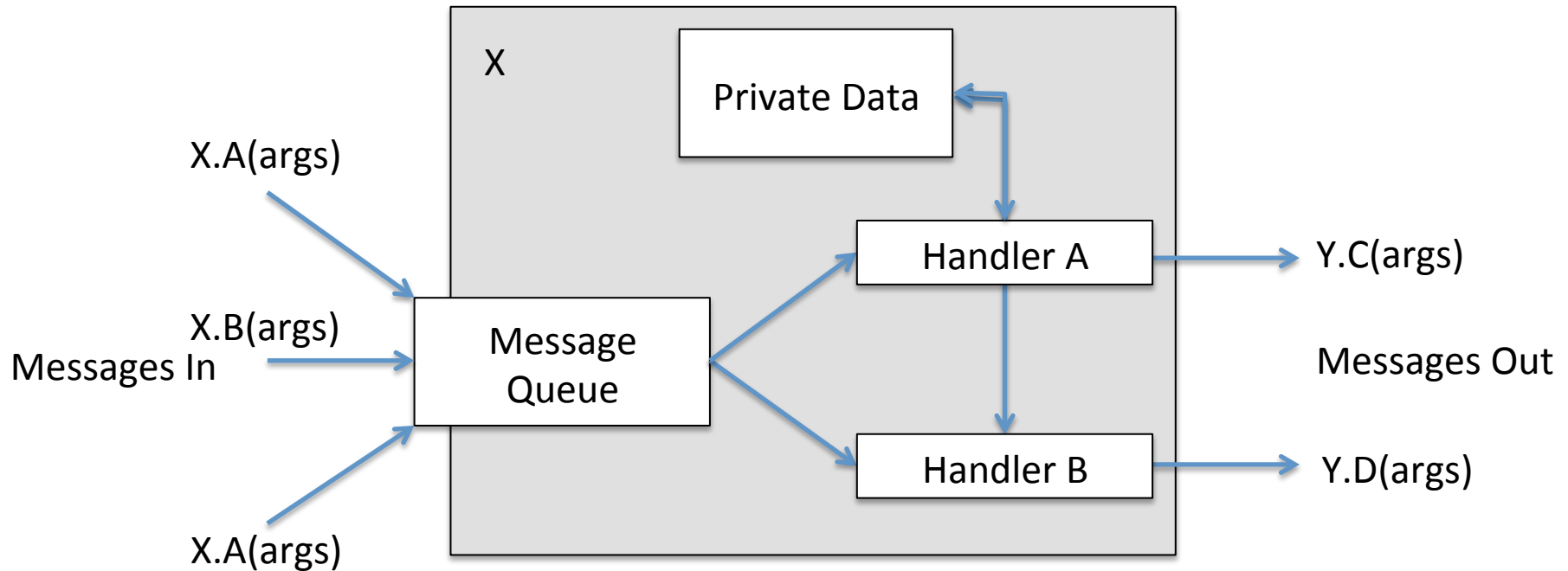

[Hewitt, 1977] [Agha, 1986, 1990, 1997]



Example with Two Actors

```
Actor Source {  
  handler main() {  
    x = new Door();  
    x.disarm_door();  
    x.open_door();  
  }  
}
```

What assumptions are needed for it to be safe for the handler to open the door?

```
Actor Door {  
  handler open_door() {  
    ...  
  }  
  handler disarm_door() {  
    ...  
  }  
}
```



Example with Three Actors

```
Actor Source {  
  handler main() {  
    x = new Door();  
    p = new PassDisarm();  
    p.pass();  
    x.open_door();  
  }  
}
```

```
Actor PassDisarm {  
  handler pass(Door x) {  
    x.disarm_door();  
  }  
}
```

```
Actor Door {  
  handler open_door() {  
    ...  
  }  
  handler disarm_door() {  
    ...  
  }  
}
```

Now what assumptions are needed for it to be safe for the handler to open the door?



Possible Solutions

1. Ignore the problem
2. Model timing
3. Change the model of computation:
 - Dataflow (DF)
 - Kahn Process Networks (KPN)
 - Synchronous/Reactive (SR)
 - Discrete Events (DE)

[Lohstroh and Lee, “Deterministic Actors,” Forum on Design Languages (FDL), 2019]



DE Solution

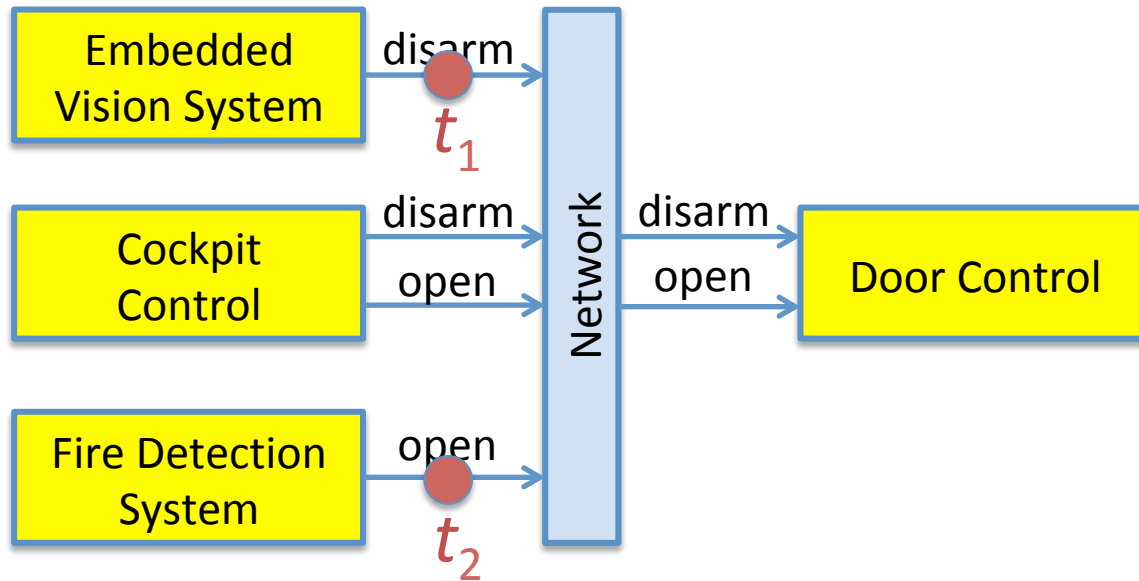

Correct behavior is now defined: Process events in timestamp order.



Discrete Events (DE)

A few texts that use the DE MoC

- Events that are processed in timestamp order.
- Widely used in simulation
- Foundation of hardware description languages.
- A deterministic concurrent MoC.
- But how to realize on distributed machines?

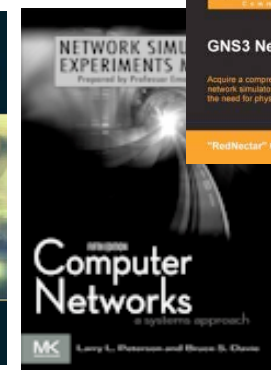
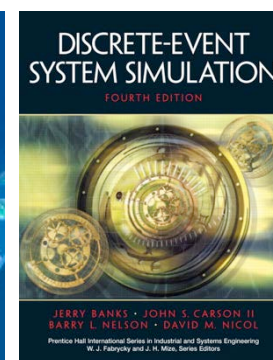
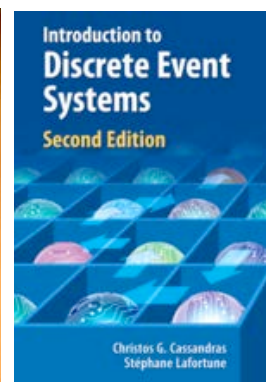
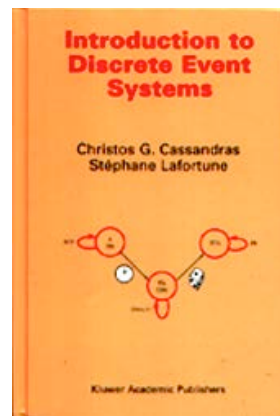
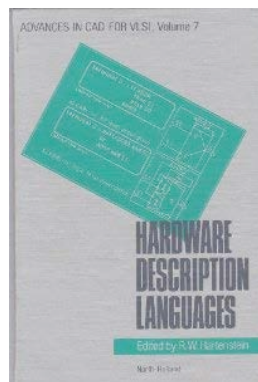
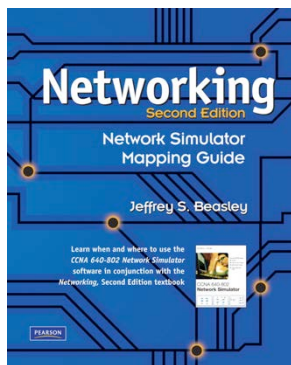
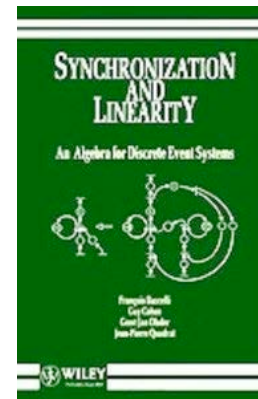



Warning

Any discussion of Discrete-Event systems involves (at least) two time lines: logical and physical.

Natural languages have no constructs for talking about two or more time lines at the same time.



Example: Google Spanner A Globally Distributed Database

Update to a record comes in. Time stamp t .

Distributed database with redundant storage and query handling across data centers.



Query for the same record comes in. Time stamp r .



Example: Google Spanner A Globally Distributed Database

Semantics of the database is that it handles queries in timestamp order.

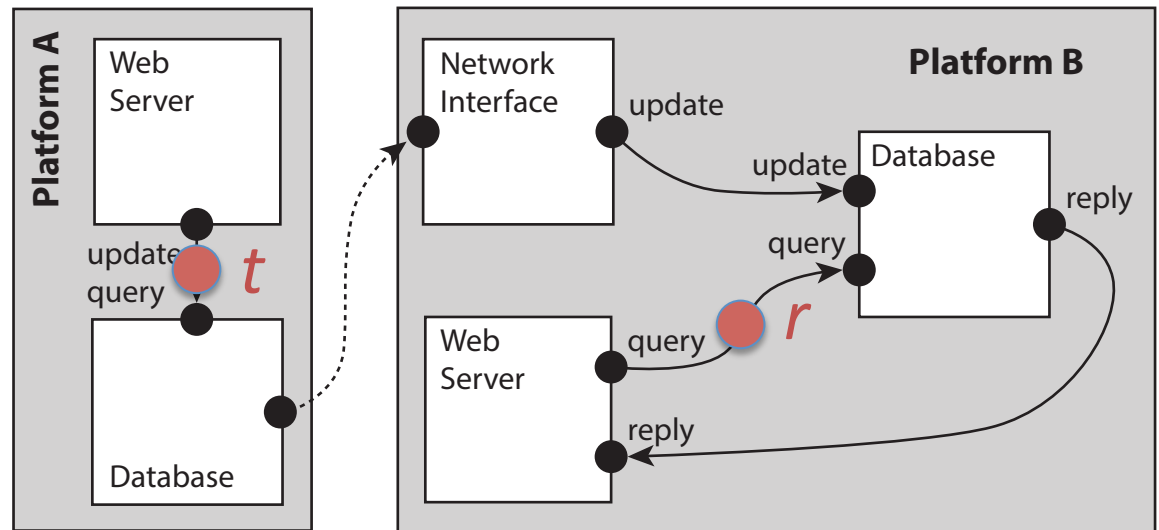

[Corbet, et al., "Spanner: Google's Globally-Distributed Database," OSDI 2011]



One Possible Approach: Chandy and Misra [1979]

- Assume events arrive reliably in timestamp order.
- Wait for events on each input.
- Process the event with the smaller timestamp.
- E.g. $r_1 < t_1$

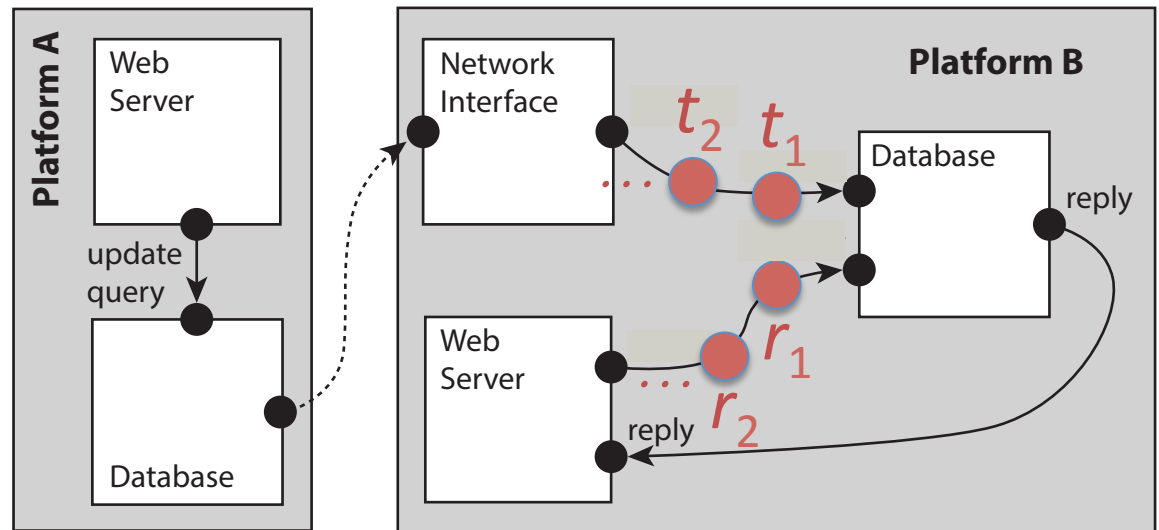



One Possible Approach: Chandy and Misra [1979]

- Deterministic
- Network traffic for “null messages.”
- Every node is a single point of failure.

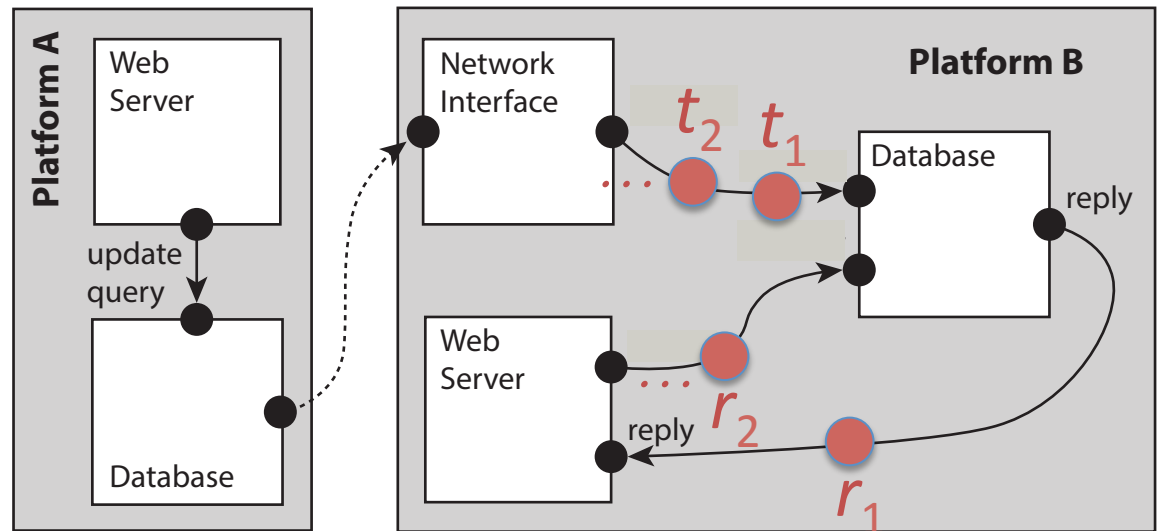



Another Possible Approach: Jefferson: Time Warp [1985]

- Speculatively execute.
- If a message with an earlier timestamp later arrives...

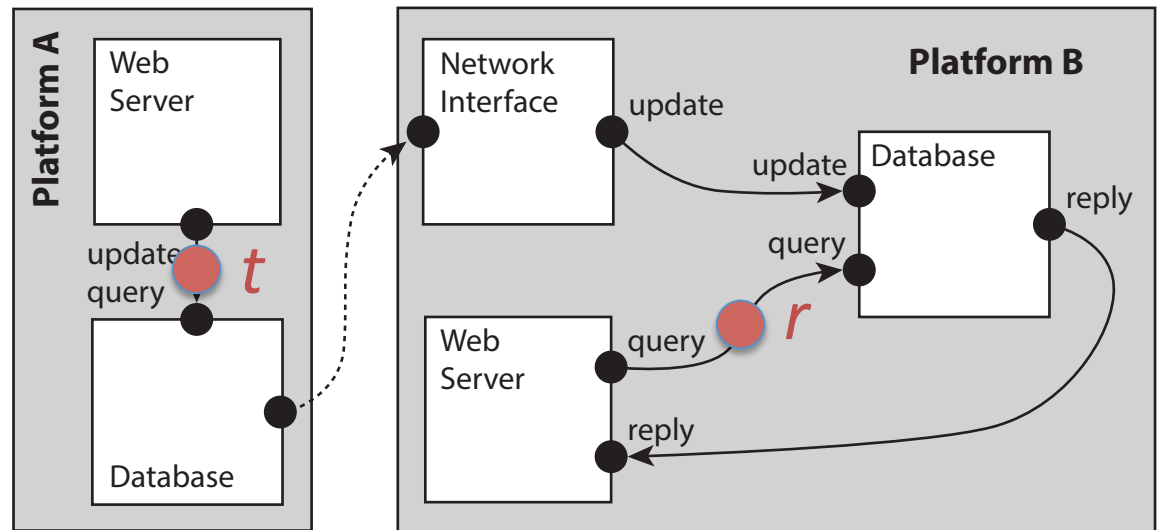



Another Possible Approach: Jefferson: Time Warp [1985]

- Speculatively execute.
- If a message with an earlier timestamp later arrives...
- **Backtrack!**

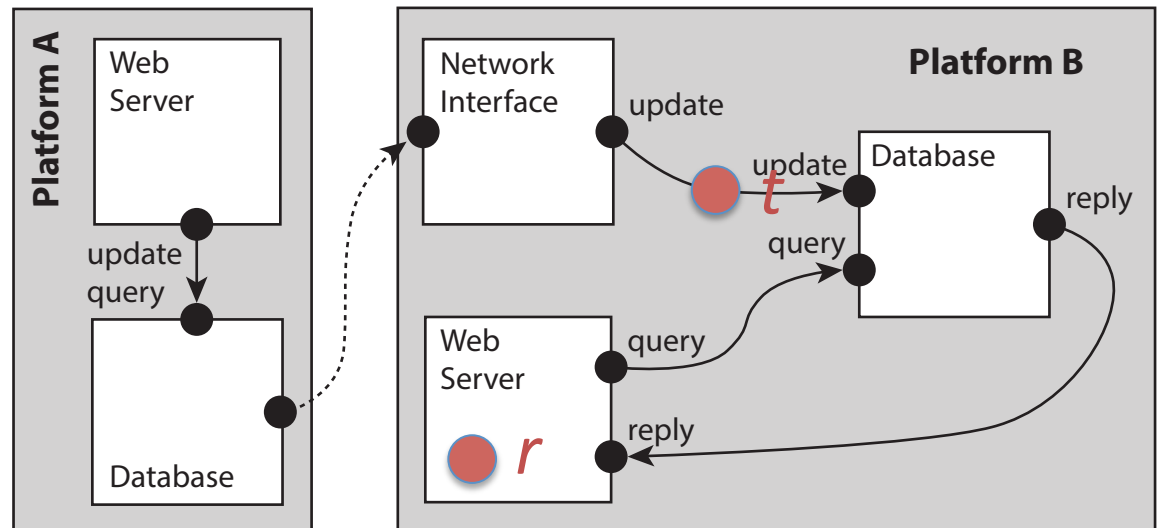



Another Possible Approach: Jefferson: Time Warp [1985]

- No single point of failure.
- Can process events without network traffic
- Can't backtrack side effects.
- Overhead: Snapshots
- Uncontrollable latencies.

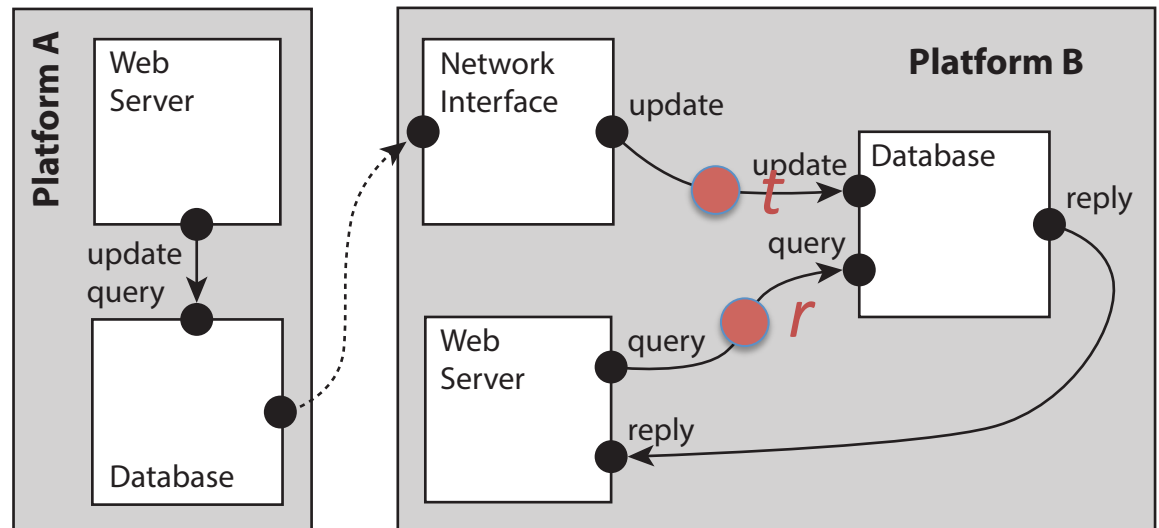



A Third Possible Approach: High Level Architecture (HLA)

- Next message request (NMR) with r
- Next message request (NMR) with t
- If $r < t$, then time advance grant (TAG) of $q \leq r$
- If $q = r$, process event

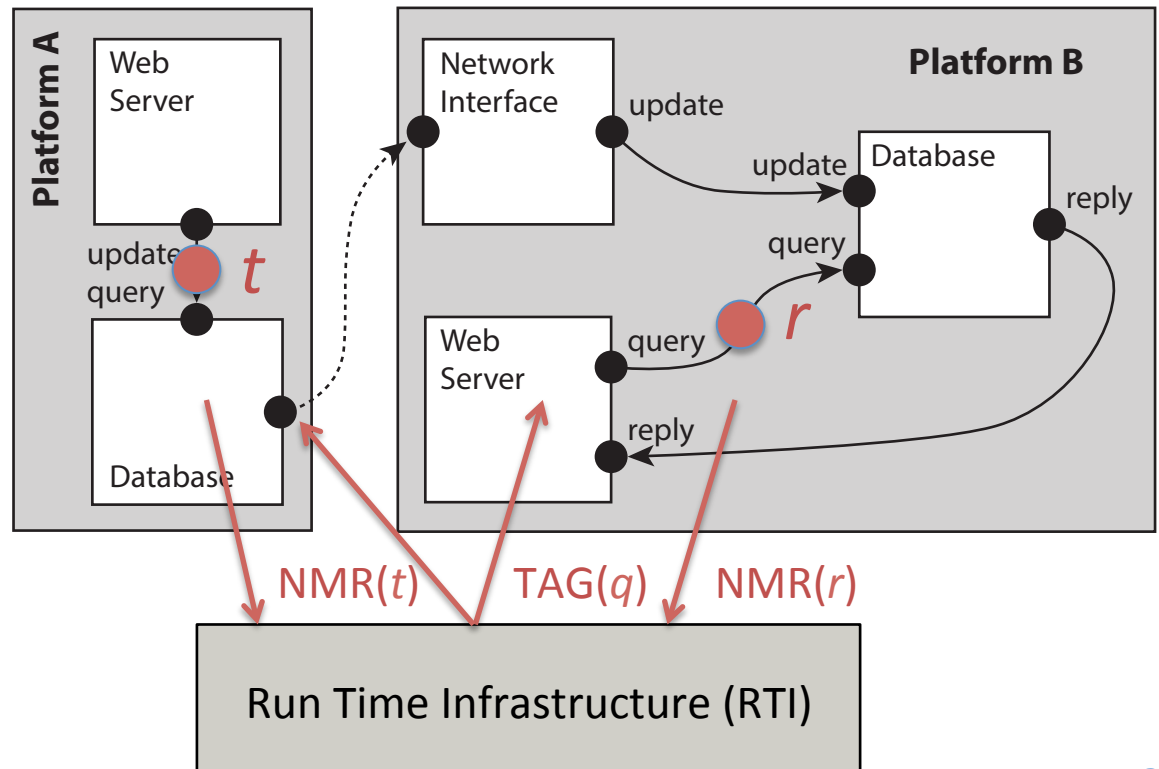



A Third Possible Approach: High Level Architecture (HLA)

- Deterministic.
- RTI is a single point of failure.
- Works well for simulation, but not for online processing.

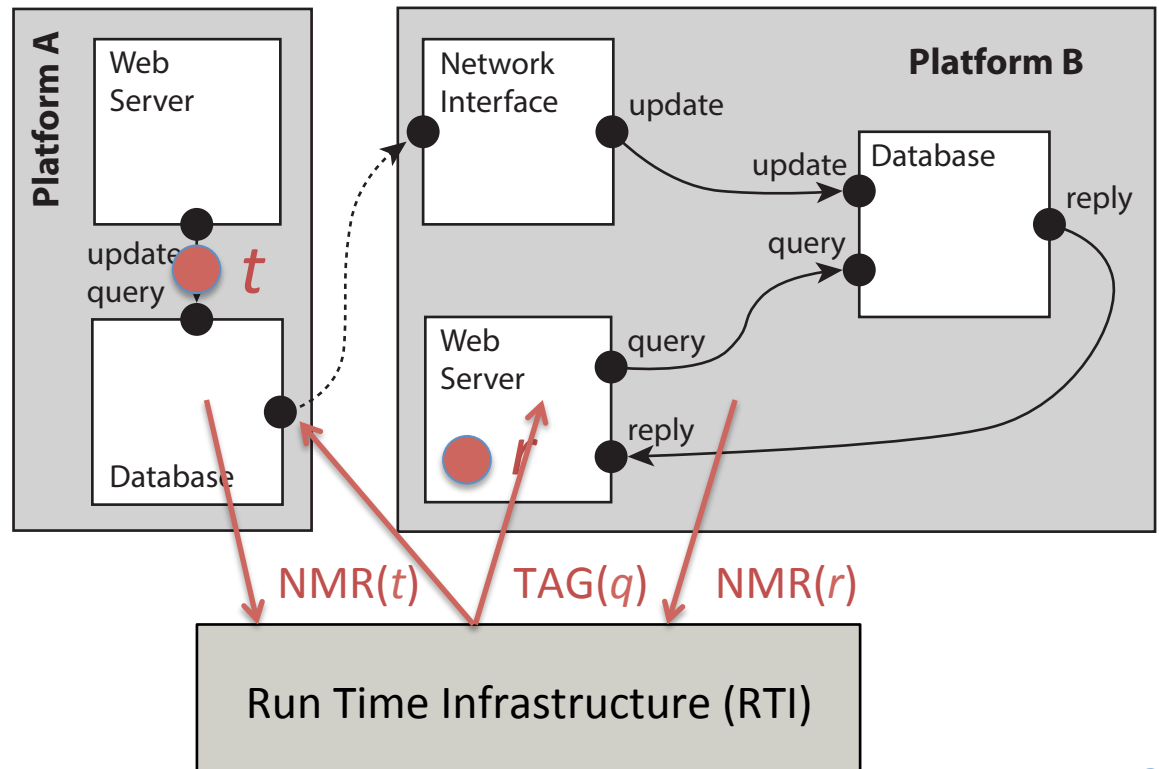



Ptides/Spanner Approach

- Local clock on each platform.
- t and r from local clocks.
- Bounded execution time W .
- Bounded network latency L .
- Event is known at **B** by time $t + W + L$ (by clock at **A**).
- Bounded clock synchronization error E .
- Event is known at **B** by time $t + W + L + E$ (by clock at **B**).

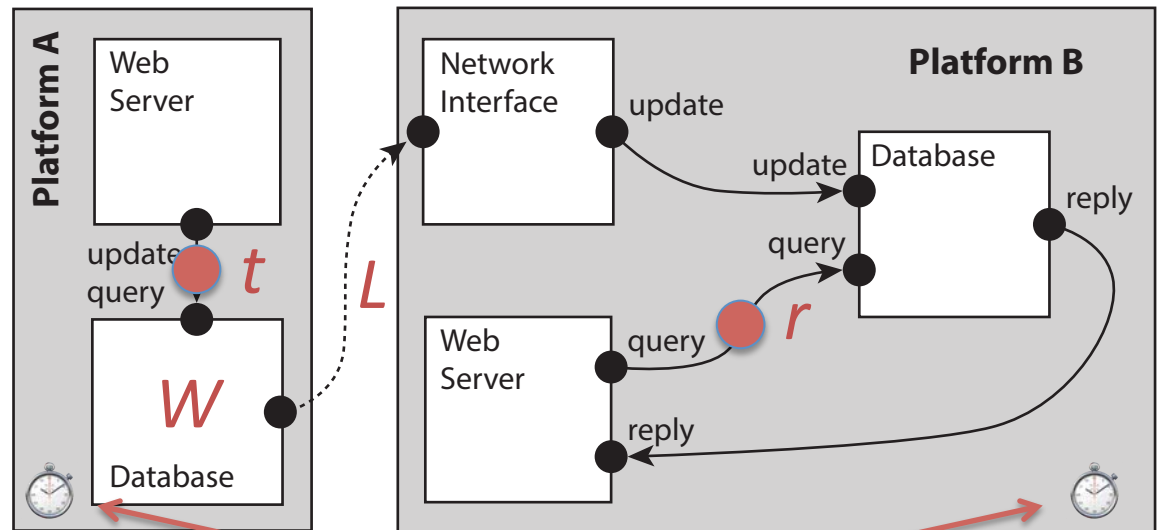

- Event with timestamp r is safe to process at time $r + W + L + E$ (by clock at **B**).



Ptides/Spanner Approach

- No single point of failure.
- Can process events with *no network traffic*.
- Latencies are well defined.
- Time thresholds computed statically.
- Assumptions are clearly stated.

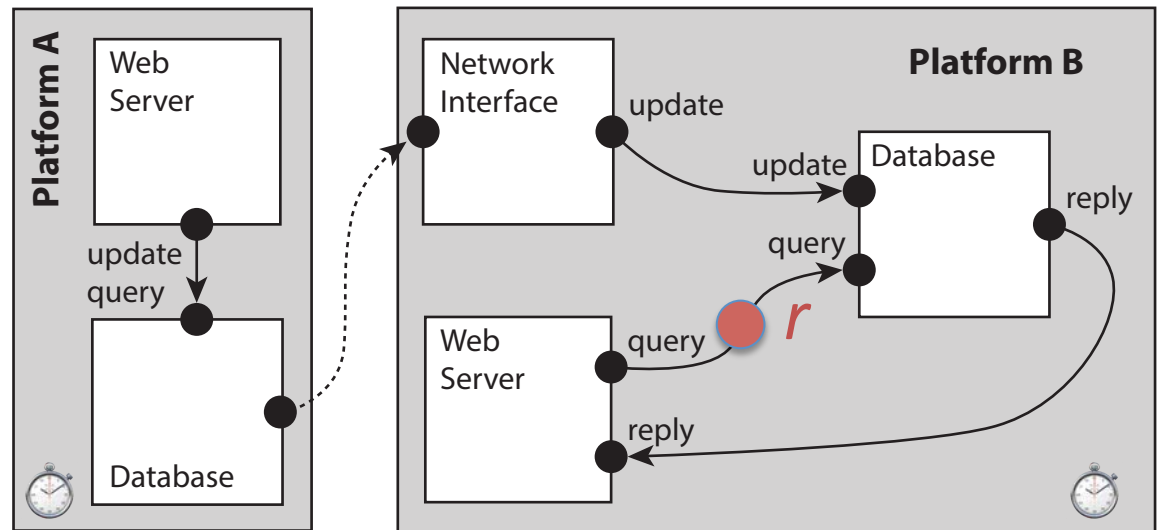

[Zhao, Liu, and Lee, "A Programming Model for Time-Synchronized Distributed Real-Time Systems," RTAS, 2007]

[Corbet, et al., "Spanner: Google's Globally-Distributed Database," OSDI 2011]



Ptides

This model was introduced in 2007 with applications to cyber-physical systems:

<http://ptolemy.org/projects/chess/ptides>

in Proceedings of the 13th IEEE Real-Time and Embedded Technology and Applications Symposium (RTAS 07) ,
Bellevue, WA, United States.

A Programming Model for Time-Synchronized Distributed Real-Time Systems

Yang Zhao
EECS Department
UC Berkeley

Jie Liu
Microsoft Research
One Microsoft Way

Edward A. Lee
EECS Department
UC Berkeley



At What Cost Determinism?

- Synchronized clocks
 - These are becoming ubiquitous
- Bounded network latency
 - Violations are *faults*. They are detectable.
- Bounded execution times
 - Only needed in particular places.
 - Solvable with PRET machines (another talk).

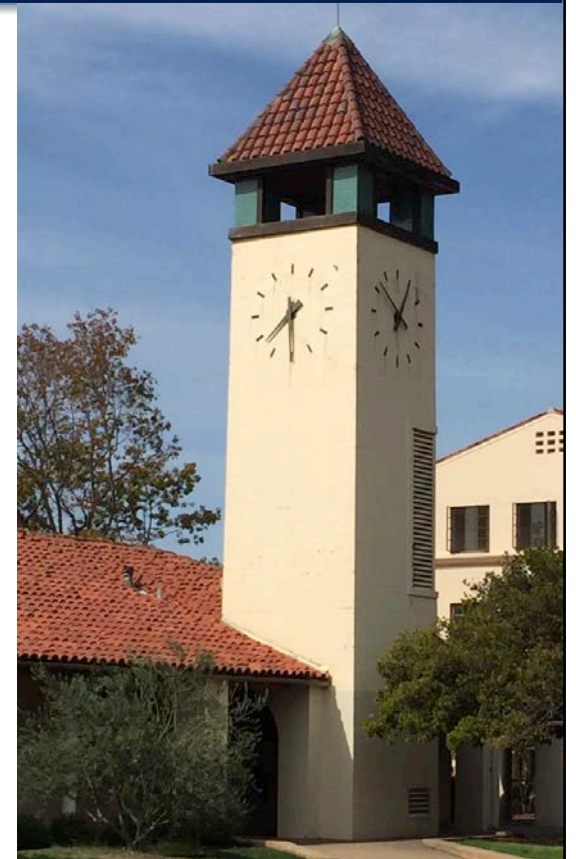



What can be verified with the PTIDES/Spanner approach?

1. If Door receives “open,” it will ~~eventually~~ open the door in bounded time, even if all other components fail.
2. If any component sends “disarm” before any other component sends “open,” and the message is received in bounded time, then the door will be disarmed before it is opened.

The first is stronger, the second weaker.

And these properties are satisfied for any program complexity.

[Zhao et al., “A Programming Model for Time-Synchronized Distributed Real-Time Systems,” RTAS 2007]



Principle

Use a MoC where:

1. Designing software that satisfies the properties of interest is easy.
2. The implementation of the MoC (the framework) is verifiably correct under reasonable, clearly stated assumptions.

The hard part is 2, where it should be, since that is done once for many applications.

"Keep the hard stuff out of the application logic"



Today: Lingua Franca

A polyglot meta-language for deterministic, concurrent, time-sensitive systems.

Lingua Franca Wiki

Topics

- [Overview](#)
- [Language Specification](#)
- [Writing Reactors in C](#)
- [Accessors Target](#)
- [Downloading and Building](#)

Papers

- [FDL 2019 paper on Deterministic Actors.](#)
- [EMSOFT 2019 work-in-progress paper.](#)
- [DAC 2019 paper on Reactors.](#)

► Pages **15**

Contents

Overview

- [Reactors](#)
- [Time](#)
- [Real-Time Systems](#)
- [References](#)

Language Specification

- [Reactor Block](#)
 - [Parameter Declaration](#)
 - [State Declaration](#)
 - [Input Declaration](#)

<https://github.com/icyphy/lingua-franca/wiki>



Hello World in Lingua Franca

```
target C;  
main reactor HelloWorld {  
  reaction(startup) {=  
    printf("Hello World.\n");  
  }  
}
```

Target language (currently C, C++, and TypeScript. Plans for Python, Rust, Java)

Arbitrary code in the target language.

Events of various kinds trigger reactions



Hierarchical Composition and Ports

```
reactor A {  
  output y;  
  ...  
}  
reactor B {  
  input x;  
  ...  
}  
main reactor C {  
  a = new A();  
  b = new B();  
  a.y -> b.x;  
}
```

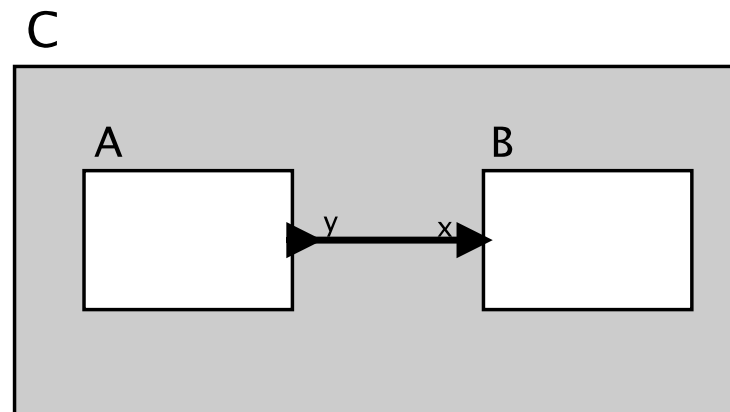



Application Sketch

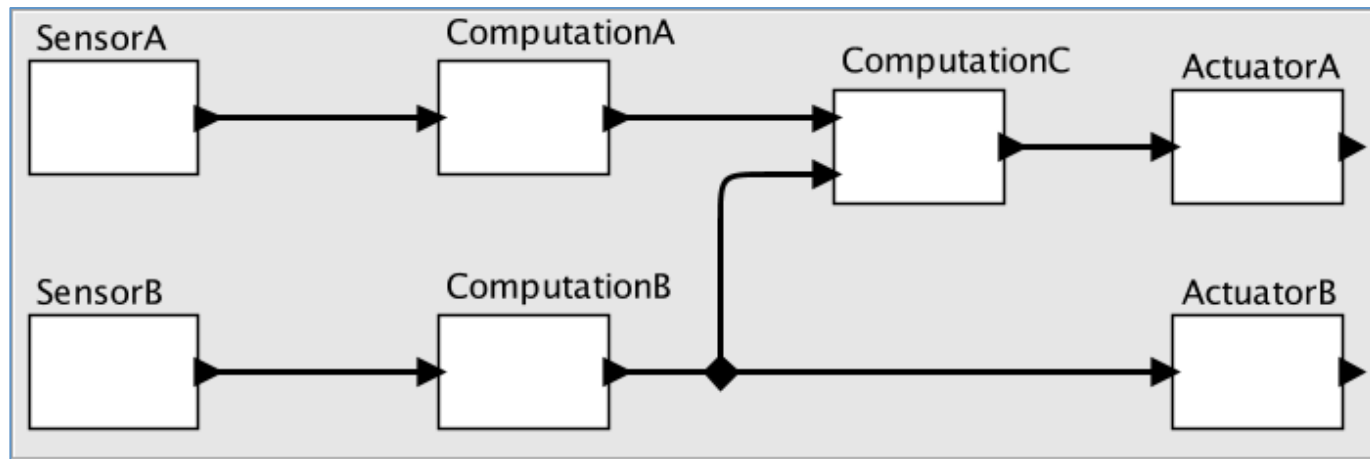



Reactors

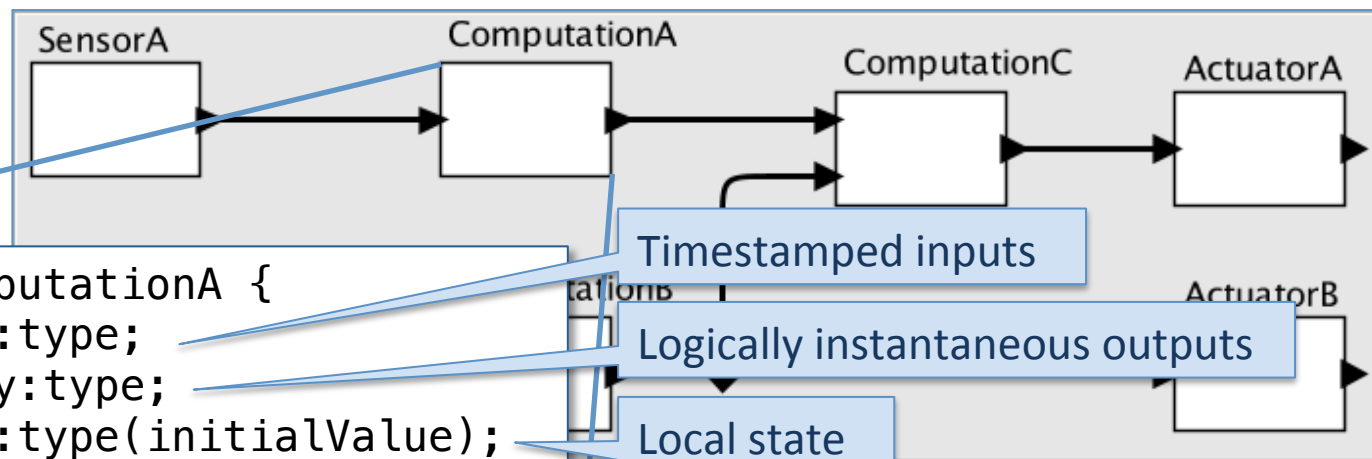

```
reactor ComputationA {  
  input x:type;  
  output y:type;  
  state s:type(initialValue);  
  reaction(x) -> y {=  
    Target-language code  
    referencing x, y, and s.  
  }  
}
```

Timestamped inputs

Logically instantaneous outputs

Local state

Reaction signature gives trigger(s) and production



Determinism

```
reactor Add {  
  input in1:int;  
  input in2:int;  
  output out:int;  
  reaction(in1, in2) -> out {=  
    int result = 0;  
    if (in1_is_present) {  
      result += in1;  
    }  
    if (in2_is_present) {  
      result += in2;  
    }  
    set(out, result);  
  }  
}
```

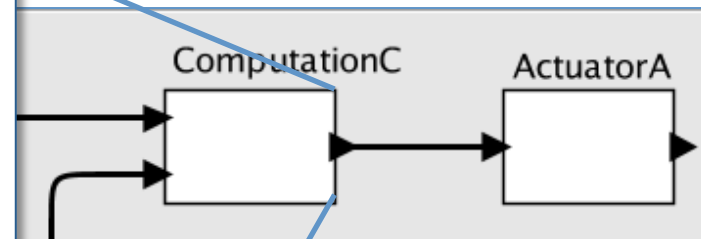

Whether the two triggers are present simultaneously depends only on their timestamps, not on when they are received nor on where in the network they are sent from.



Periodic Behavior

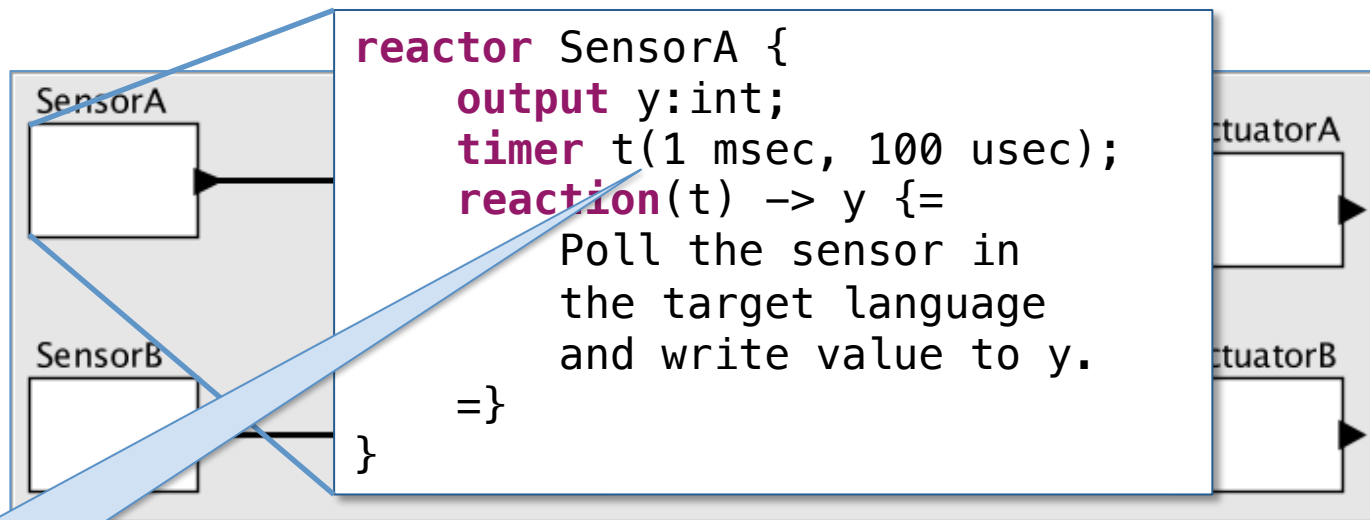

Time as a first-class data type.

In our C target, timestamps are 64-bit integers representing the number of nanoseconds since Jan. 1, 1970 (if the platform has a clock) or the number of nanoseconds since starting (if not).



Event-Triggered Behavior

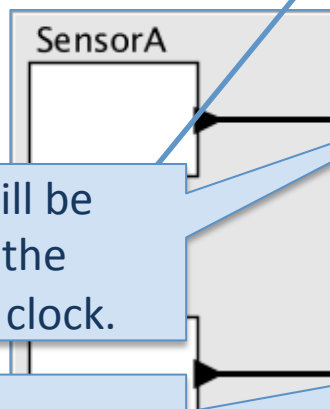

Timestamp will be derived from the local physical clock.

ISR executes asynchronously, and schedule() function is thread safe.

```
reactor SensorB {  
  output y:int;  
  physical action a:int;  
  timer start;  
  reaction(start) -> a {=  
    Set up an interrupt service  
    routine that will call:  
    schedule(a, 0, value);  
  }=  
  reaction(a) -> y {=  
    set(y, a_value);  
  }=  
}
```



Deadlines

```
reactor ActuatorA {  
  input in:int;  
  reaction(in) {=  
    perform actuation.  
  } deadline 10 msec {=  
    handle deadline violation.  
  }  
}
```

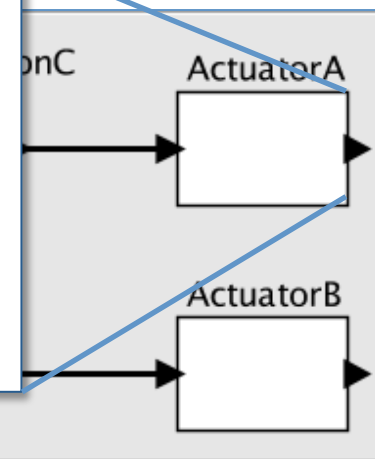

Deadline is violated if the input d.x triggers more than 10 msec (in physical time) after the timestamp of the input.



Status

<https://github.com/icyphy/lingua-franca>

Still early, but evolving rapidly.

- Eclipse/Xtext-based IDE
- C, C++, and TypeScript targets
- Code runs on Mac, Linux, Windows, and bare iron
- Command-line compiler
- Regression test suite
- Wiki documentation



Performance

Behaviors of the C target in the regression tests running on a 2.6 GHz Intel Core i7 running MacOS:

- Up to 23 million reactions per second (43 ns per).
- Linear speedup on multiple cores.
- Code size is tens of kilobytes.



Clock Synchronization

- NTP is widely deployed but not precise enough.
- PTP (IEEE 1588) is widely supported in networking hardware.
- Lingua Franca can work without clock synchronization by reassigning timestamps to network messages.
 - In this case, determinism is preserved within each multicore platform, but not across platforms.
- Lingua Franca can work without clock sync. using an RTI (like HLA)
 - With careful mapping of reactors to federates, this can be efficient.



Work in Progress

- Distributed execution based on Ptides.
- Distributed execution based on HLA.
- EDF scheduling on multicore.
- Targeting PRET machines for hard real time.
- Formal verification of Lingua Franca apps
- Leverage Google's Protobufs and gRPC.
 - Complex datatypes
 - Polyglot systems



PRET targets

PRET machines: microarchitectures with precise timing control.

<http://ptolemy.org/projects/chess/pret>

With PRET machines, we can deploy systems where deadlines are provably never violated (with explicitly stated assumptions).



Questions That can be Addressed by Lingua-Franca

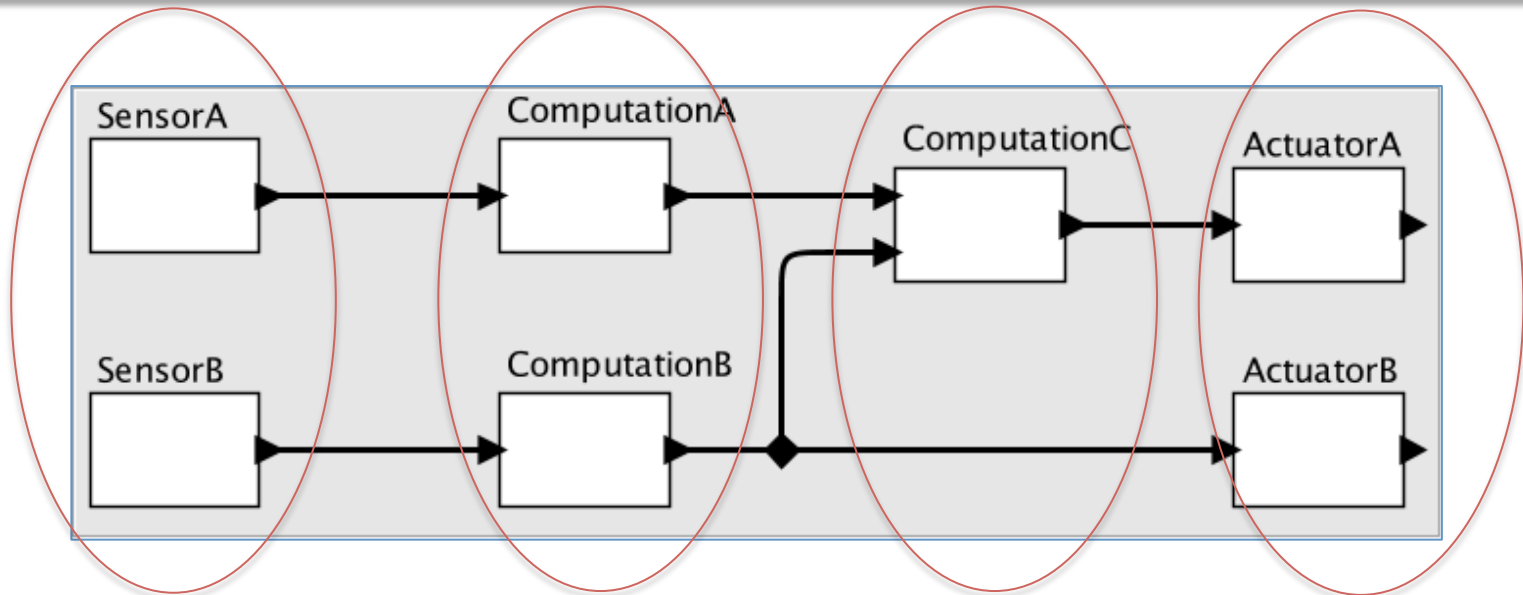

What combinations of periodic, sporadic, behaviors are feasible?

How do execution times affect feasibility?
How can we know execution times?

How do we get repeatable and testable behavior even when communication is across networks?

How do we specify, ensure, and enforce deadlines?



Conclusions

- Lingua Franca programs are **testable** (timestamped inputs -> timestamped outputs)
- LF programs are **deterministic** under *clearly stated assumptions*.
- Violations of assumptions are **detectable** at run time.
- Actors, Pub/Sub, SoA, and shared memory have **none of these properties**.

<https://github.com/icyphy/lingua-franca/wiki>